



freedomRail is the only truly adjustable storage system to differentiate your project and with the quality that you can put your name behind. freedomRail is the strongest, easiest to use and the most versatile. freedomRail is solving the consumer's storage solutions while making your work easy.

### Why specify freedomRail?

- Consumers demand storage! It's important to the end product that they use day to day. Put your name on a project that they love.
- freedomRail makes it easy with the latest in technology to save you time and resources. Visit [OrganizedLiving.com](http://OrganizedLiving.com) or [Modlar.com](http://Modlar.com) to download 3-part specs and BIM objects for your next project.
- Because freedomRail is the highest quality storage solution, you can feel confident that you can jump through all the hoops and your spec will be accepted.
- freedomRail is manufactured with furniture grade melamine and the highest steel gauge with epoxy powder coating.
- freedomRail strong is guaranteed and therefore helps you create strong relationships in the industry. Your partners will thank you for specifying freedomRail.
- freedomRail also is easy to install. After a simple design process, it goes on the wall just as easy. There are no extras. And minimal hardware provides maximum strength.
- The freedomRail system is green – there are no VOCs and no PVC and it's CARB compliant.
- freedomRail is qualified as made in the USA.
- Efficient storage maximizes the smaller floorplans that you are asked to design.

**Get started today! Visit [OrganizedLiving.com](http://OrganizedLiving.com) now or [Modlar.com](http://Modlar.com).**

# freedomRail is the most innovative concept in home storage and organization.

It provides all the benefits of a custom closet while being easy to install, easy to adjust and easy to upgrade.

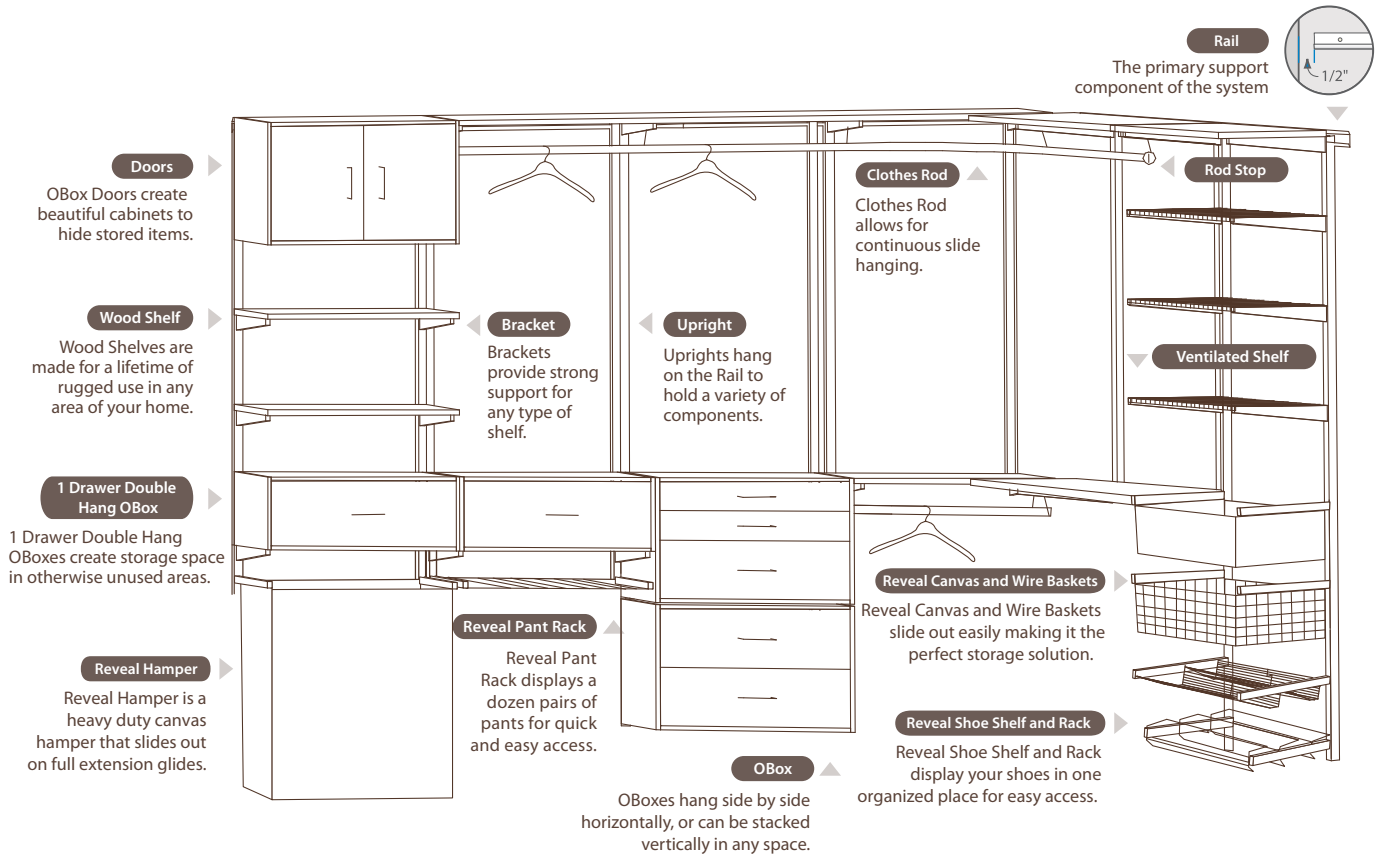

## Easy to Install.

Using a level and a drill, attach the Rail to the wall. After that, all other components simply snap into place. No complicated instructions and no confusing parts and pieces. You'll be astonished at how quickly freedomRail installs!

## Easy to Adjust.

All components are designed for a lifetime of use. Reposition shelves to fit a growing child or move pantry shelves to accommodate a blender. Changes are a snap!

## Easy to Upgrade.

Place a Rail in every closet of your project and then choose from a variety of options to customize that storage space. Shelving can be ventilated or solid.

OBoxes can be added to any closet for enclosed storage. Make the storage work for you.



## Rail and Uprights

### General Information:

- System relies on horizontal rail as primary structural support.
- Vertical uprights hang from the rail.
- The rail is not dependent on stud locations.
- All components designed with adjustability in mind.

### Colors:

- White (-11)
- Nickel (-45)
- Granite (-50)

### Material Specifications:

- .079" (2.0mm) 1008 steel.

### Installation:

- Countersunk holes in the rail are placed every 8" on center (except on 30" and 36" rails). Hardware provided in the #9137 package enables mounting into:
  - hollow walls
  - studs
  - masonry
- When installing into drywall, use 7913-9137-11, StrongLoc Anchor.
- Use rail mounting holes every 8"
- Uprights are then hung from the rail. A 9/32" hole in the bottom of the Upright further secures Upright to wall using a 7913-9137-11 with spacer. This procedure is not necessary but eliminates possible swaying of the upright.
- For heavier loads, secure the rail into studs every 16". Space uprights every 24"

### Upright Spacing & Weight Capacities:

- General spacing of Uprights depends on the type of shelf and the desired use. See chart for detail on spacing guidelines.
- Weight capacities depend on the type of shelf used and the spacing of Uprights. See chart for weight guidelines.

### Miscellaneous:

- All measurements are  $\pm 1/8"$  (2mm).
- Drawings are not to scale.
- See Bracket Specifications for load capacities.

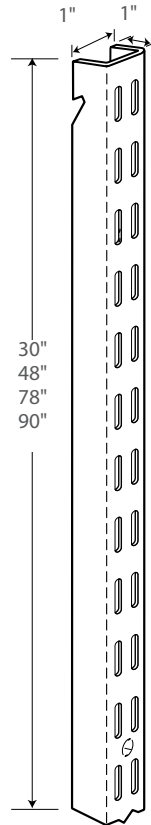
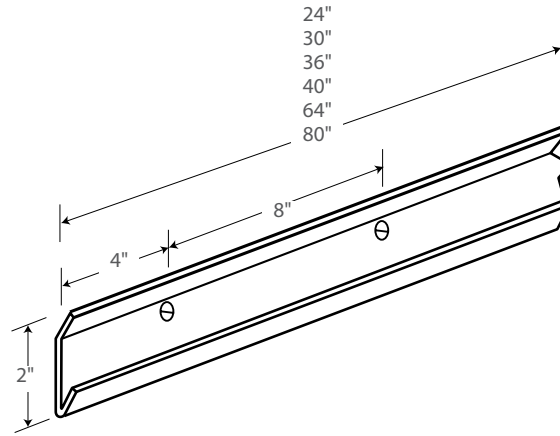

Hanging Upright Spacing			
	24"	30"	36"
Ventilated	100 lbs/ft	75 lbs/ft	50 lbs/ft
Wood	100 lbs/ft	75 lbs/ft	50 lbs/ft

## Rail

### 7913-4424-11 (-45,-50)

Length: 24"  
61.0cm  
Screw Holes: 3  
Case: 8

### 7913-4430-11 (-45,-50)

Length: 30"  
76.2cm  
Screw Holes: 4  
Case: 8

### 7913-4436-11 (-45,-50)

Length: 36"  
91.44cm  
Screw Holes: 5  
Case: 8

### 7913-4440-11 (-45,-50)

Length: 40"  
101.6cm  
Screw Holes: 5  
Case: 8

### 7913-4464-11 (-45,-50)

Length: 64"  
162.6cm  
Screw Holes: 8  
Case: 8

### 7913-4080-11 (-45,-50)

Length: 80"  
203.2cm  
Screw Holes: 10  
Case: 8

## Uprights

### 7913-3530-11 (-45)

Length: 30"  
76.2cm  
Screw Holes: 1  
Case: 6

### 7913-3548-11 (-45,-50)

Length: 48"  
121.9cm  
Screw Holes: 1  
Case: 6

### 7913-3578-11 (-45,-50)

Length: 78"  
198.1cm  
Screw Holes: 1  
Case: 6

### 7913-3590-11 (-45,-50)

Length: 90"  
228.6cm  
Screw Holes: 1  
Case: 6

# Shelf Brackets - Ventilated Shelving

## General Information:

- Double wall construction provides adjustability in heavy duty applications
- Four clips allow brackets to mount into uprights.
  - Top two tabs hold weight
  - Bottom two clips stabilize bracket and prevent it from being knocked up and out of upright.
- Bracket lengths represent the overall length from the face of the upright
- Bracket extends at a 1 degree incline from back of bracket (with exception of 7913-1413-11 which extends 90 degrees to match angle when placed next to OBox)
- Bracket load capacity calculated assuming even loading over length of bracket
- Weight load capacity of brackets depends on properly installed uprights
- All brackets fit all uprights

## Colors:

- White (-11) in all sizes
- Nickel (-45) in 12", 16" and slanted shoe shelf bracket
- Granite (-50) in 12" and 16"

## Material Specifications:

- .065" (1.6mm) 1008 steel.
- Single piece of formed steel

## Installation:

- Ventilated shelves lock into bracket without additional hardware (see below) and cannot be unintentionally removed.

## Bracket/Upright Spacing:

- General spacing of uprights and brackets:
  - 36" standard closet use
  - 30" pantries and garages
  - 24" extra heavy duty use

## Miscellaneous:

- All measurements are  $\pm 1/8"$  (2mm).
- Drawings are not to scale.

For ventilated shelving

9" (229mm)

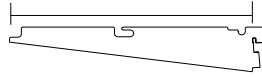

for ventilated shelving. Also supports optional clothes rod

12" (311mm)

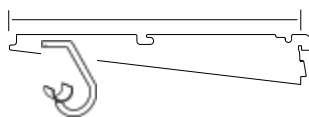

16" (413mm)

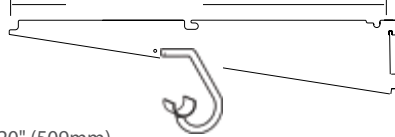

20" (509mm)

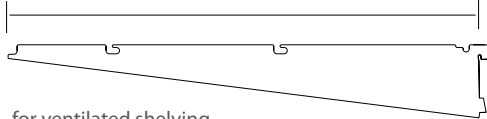

for ventilated shelving

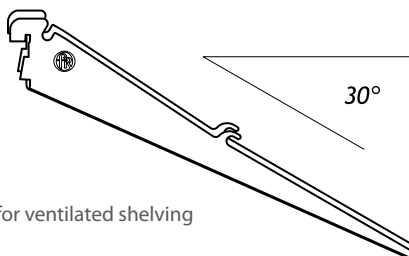
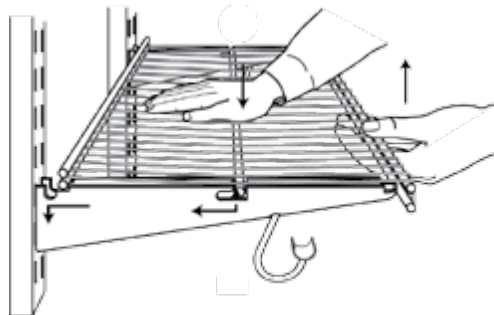

for ventilated shelving

## Ventilated Shelving Brackets

### 7913-1309-11

Type of Shelf:	Ventilated
Length:	9.375" 229mm
Load capacity:	110 lbs 50 kg
Case:	10 or 50

### 7913-1412-11 (-45,-50)

Type of Shelf:	Ventilated
Length:	12.25" 311mm
Load capacity:	110 lbs 50 kg
Case:	10 or 50

### 7913-1416-11 (-45,-50)

Type of Shelf:	Ventilated
Length:	16.25" 413mm
Load capacity:	140 lbs 77 kg
Case:	10 or 30

### 7913-1320-11 (-45)

Type of Shelf:	Ventilated
Length:	20.05" 509mm
Load capacity:	130 lbs 59 kg
Case:	10

## Slanted Shoe Shelf Bracket

### 7913-1313-11 (-45)

Type of Shelf:	Ventilated
Length:	12.0" 305mm
Load capacity:	100 lbs 45 kg
Case:	10

## Shelf Brackets – Solid Shelving

### General Information:

- Double wall construction provides adjustability in heavy duty applications.
- Four clips allow brackets to mount into uprights
  - Top two tabs hold weight
  - Bottom two clips stabilize bracket and prevent it from being knocked up and out of upright.
- Bracket lengths represent the overall length from the face of the upright.
- Bracket load capacity calculated assuming even loading over length of bracket.
- Weight load capacity of brackets depends on properly installed uprights.
- All brackets fit all uprights.

### Colors:

- White (-11)
- Nickel (-45)

### Material Specifications:

- .065" (1.6mm) 1008 steel
- Single piece of formed steel

### Installation:

- Solid shelves are secured using shelf locators (double sided adhesive)
- More permanent shelf to bracket attachment with 7913-9155 shelf screws.
- Two holes on the bottom of each bracket are countersunk for #6 flathead wood screws to attach shelving.
- Required screw lengths are:
  - hole 1: #6 x 1-1/8" (29mm)\*
  - hole 2: #6 x 2" (50mm)\*
 \*assumes wood penetration of 1/2"

### Bracket/Upright Spacing:

- General spacing of uprights and brackets:
- 36" standard closet use
- 30" pantries
- 16" extra heavy duty use

### Miscellaneous:

- All measurements are  $\pm 1/8"$  (2mm)
- Drawings are not to scale

12.5" (317mm)



For wood shelving. Also supports optional clothes rod.

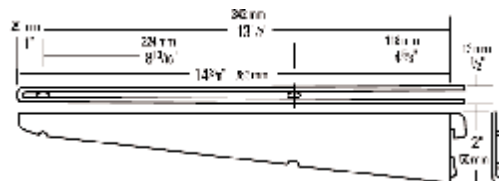
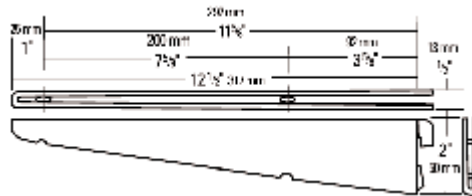
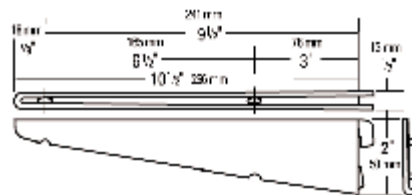
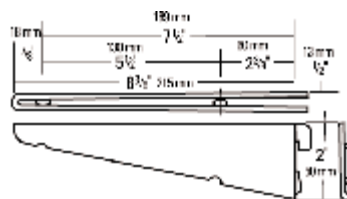
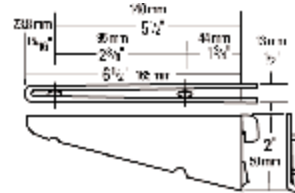

14" (356mm)



For 14" wood shoe shelf

## Wood Shelving Brackets

### 7913-1413-11

Length:	12.5" 317.5mm
Shelf Size:	
Load capacity:	130 lbs 59 kg
Case:	10 or 50

### 7913-1006-11 (-45)

Length:	6.5" 165mm
Shelf Size:	6.5" to 8.5"
Load capacity:	240 lbs 109 kg
Case:	10

### 7913-1008-11 (-45)

Length:	8.5" 215mm
Shelf Size:	8.5" to 10.5"
Load capacity:	190 lbs 86 kg
Case:	10

### 7913-1010-11 (-45)

Length:	10.5" 265mm
Shelf Size:	10.5" to 12.5"
Load capacity:	160 lbs 73 kg
Case:	10

### 7913-1012-11 (-45)

Length:	12.5" 317mm
Shelf Size:	12.5" to 14.5"
Load capacity:	130 lbs 59 kg
Case:	10

### 7913-1014-11 (-45)

Length:	14.5" 366mm
Shelf Size:	14.5" to 18.5"
Load capacity:	110 lbs 50 kg
Case:	10

### 7913-1314-11 (-45)

Length:	14" 356mm
Shelf Size:	14"
Load capacity:	100 lbs 45 kg
Case:	10

## Shelf Brackets – Heavy Duty

### General Information:

- Heavy duty brackets take up 3 sets of slots (3") on the upright
- Reinforced brackets take up 4 sets of slots (4") on the upright
- Four tabs fit into upright track
  - Top two tabs hold weight
  - Bottom two clips stabilize bracket and prevents it from being knocked up and out of upright
- Bracket lengths represent the overall length from the face of the upright
- Bracket load capacity calculated assuming even loading over length of bracket
- Weight load capacity of brackets depends on properly installed uprights
- All brackets fit all uprights

### Colors:

- White (-11)
- Nickel (-45)
- Granite (-50)

### Material Specifications:

- .065" (1.6mm) 1008 steel.
- Single piece of formed steel

### Installation:

- Wood shelves are secured using shelf locators (double sided adhesive)
  - More permanent shelf to bracket attachment with 7913-9155 shelf screws
  - All bracket holes are countersunk for #6 flathead wood screws to attach shelving. Required lengths are:
    - hole 1: #6 x 1- $\frac{1}{8}$ " (29mm)\*
    - hole 2: #6 x 2" (50mm)\*
    - hole 3: #6 x 3" (76mm)\*
- \*assumes wood penetration of 1"

### Bracket/Upright Spacing:

- General spacing of uprights and brackets: 16" extra heavy duty use

### Miscellaneous:

- All measurements are  $\pm \frac{1}{8}$ " (2mm)
- Drawings are not to scale.

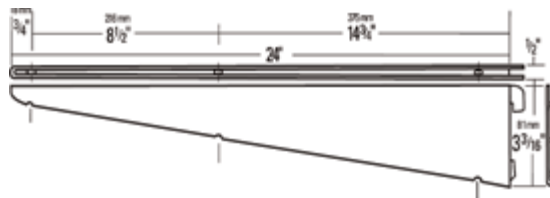
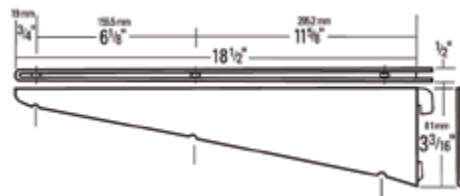
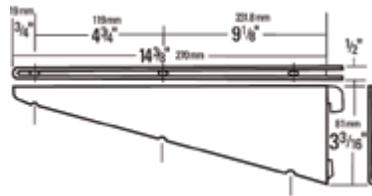

## Heavy Duty Brackets

### 7913-1114-11 (-45)

Length:	14.5"
	366mm
Shelf Size:	14.5" to 18.5"
Load capacity:	200 lbs
	91 kg
Case:	10

### 7913-1118-11 (-45, -50)

Length:	18.5"
	478mm
Shelf Size:	18.5" to 24"
Load capacity:	175 lbs
	80 kg
Case:	10

### 7913-1124-11 (-45)

Length:	24"
	608mm
Shelf Size:	24" to 28.5"
Load capacity:	165 lbs
	75 kg
Case:	10



## Clothes Rods and Rod Hardware

### General Information:

- Rod clip mounts under bracket to supply continuous hanging space.
- Clothes rod snaps firmly into place on rod clip.
- Rod stops finish off the ends of the clothes rod.

### Colors:

- Chrome (-34)
- Nickel (-36)

### Material Specifications:

- Rod clip:
  - .1875" (4.8mm) steel.
- Clothes rod:
  - Chrome plated steel tubing
- Rod stop:
  - 1/8" steel plate.

### Miscellaneous:

- All measurements are  $\pm 1/8"$  (2mm).
- Drawings are not to scale.

### Installation for rod clip 7913-1500:

- Mount rod clip through hole in bottom of bracket

### Installation for rod stop 7913-1510:

- Insert rod stop into end of clothes rod.
- Turn until snug.

### Installation for clothes rod 7913-

#### 1524/30/36/48/96:

- Snap clothes rod into rod clips.

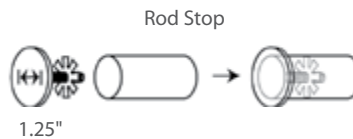
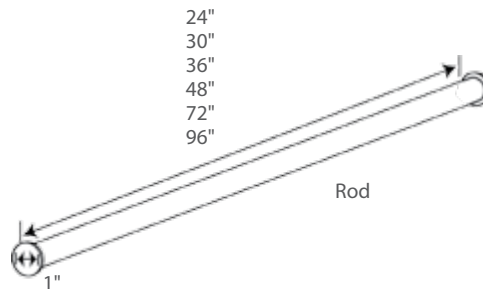
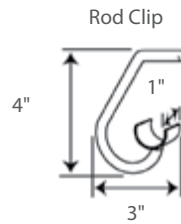

## Rod Clip

### 7913-1500-34 (-36)

Length:	4"
Case:	10.7cm 12 or 50

## Clothes Rod

### 7913-1524-34 (-36)

Length:	24"
Case:	61.0cm 8

### 7913-1530-34 (-36)

Length:	30"
Case:	76.2cm 8

### 7913-1536-34 (-36)

Length:	36"
Case:	91.4 cm 8

### 7913-1548-34 (-36)

Length:	48"
Case:	121.9cm 8

### 7913-1572-34 (-36)

Length:	72"
Case:	182.9cm 8

### 7913-1596-34 (-36)

Length:	96"
Case:	243.8cm 8

## Rod Stop

### 7913-1510-34 (-36)

Diameter:	1.25"
Case:	3.2cm 12 pairs or 50 pairs

## Hardware

### General Information:

- Hardware to mount freedomRail into any substrate.

### Miscellaneous:

- All measurements are  $\pm 1/8"$  (2mm).
- Drawings are not to scale.

### Installation for mounting screws and anchors 7913-9137:

When installing the rail:

- Drill  $5/16"$  hole and insert anchor firmly into wall.
- Tighten screws into anchors using #2 Phillips bit. After screw is flush, give screw 6 to 8 more turns to allow anchor to tighten behind the wall.
- If mounting into studs, drill pilot holes every 16" using  $5/32"$  drill bit.
- If mounting into concrete, drill pilot holes every 16" using  $5/16"$  drill bit.

### Installation for shelf locator 7913-9158:

- Two (2) shelf connectors are recommended for each bracket. Locate one 1" from the rear of the shelf and locate another at the front of the shelf.
- If securing shelf locator to bracket, first secure shelf locator to bracket using optional  $1/2"$  screw, then secure shelf locator to shelf.
- Drill pilot hole in wood shelf with  $3/32"$  drill  $1/2"$  deep, locate locator as shown.

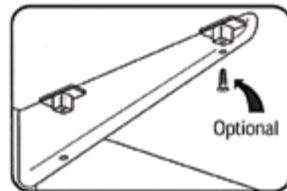
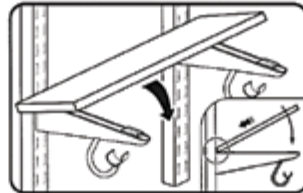
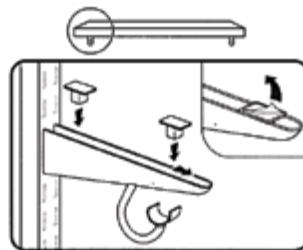
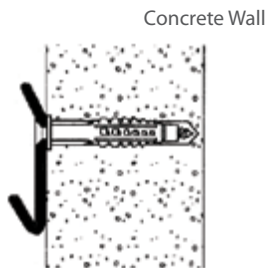
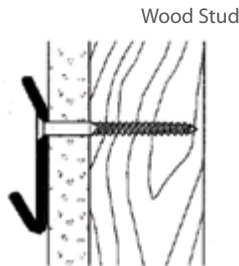
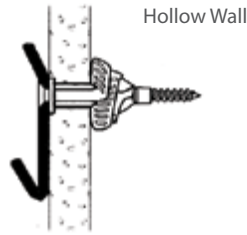

Shelf Locator

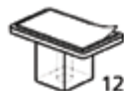

## Strong-Loc™ Anchors

### 7913-9137-11

- Used to attach rail and uprights to wall
- For wood, masonry and hollow wall applications.
- Includes:
  - Six  $5/16"$  universal anchors
  - Six #10 x  $2-3/4"$  Phillips flathead wood screws
  - One packet adhesive screw head covers to hide exposed screw heads.

## Shelf Locator

### 7913-9158-11

- Used to secure wood shelving to wood shelf brackets.
- Includes:
  - Twelve (12) plastic shelf connectors with tape.
  - Six (6) #6 x 1" Phillips pan head wood screws.
  - To secure wood shelving to bracket.
- Shelf locator can rest in the bracket or be permanently attached to the bracket with an optional screw.



## Hardware – To Attach Shelves

### General Information:

- Hardware packages for heavy duty freedomRail mounting systems options.

### Miscellaneous:

- All measurements are  $\pm 1/8"$  (2mm).
- Drawings are not to scale.

### Installation for shelf screws 7913-9155:

- Drill pilot hole in shelf with  $3/32"$  drill  $1/4"$  deep.
- Use 2" screws for back holes in brackets  $1-1/8"$  for front holes.

### Installation for heavy duty shelf locator 7913-9159:

- Use pan head screws to attach shelf locator to shelving. Use flat head screws to attach shelf locator to bracket (optional).
- Minimum of two heavy duty shelf locators are recommended for each bracket. If locator to rest in bracket, locate one 1" from the rear of the shelf and locate second at front of shelf.
- If securing locator to bracket, first secure locator to bracket, then secure locator to shelf.
- Drill pilot holes into shelf with  $3/32"$  drill  $1/4"$  deep and attach locator as shown.

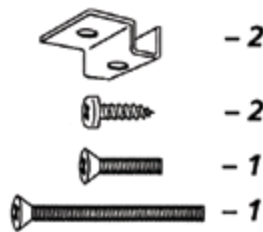
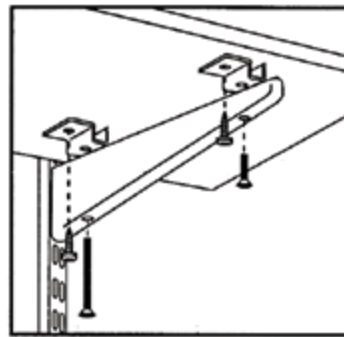
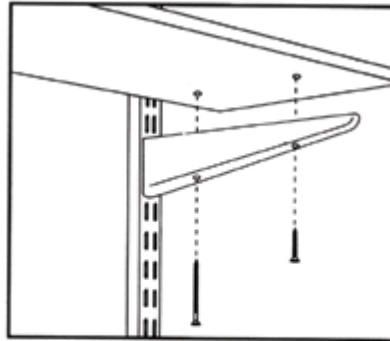

## Shelf Screws

### 7913-9155-11

- Includes:
  - Six  $5/16"$  universal anchors
  - Six #10 x  $2-3/4"$  Phillips flathead wood screws
  - One packet adhesive screw head covers to hide exposed screw heads.
- Secures  $1"$  (19mm) shelving to wood shelf brackets

## Heavy Duty Shelf Locator

### 7913-9159-11

- To secure  $1"$  (19mm) or thicker wood shelf to bracket.
- Includes:
  - Twelve (12) plastic shelf connectors with tape.
  - Six (6) #6 x  $1"$  Phillips pan head wood screws.
  - To secure wood shelving to bracket.
- Shelf locator can rest in the bracket or be permanently attached to the bracket with an optional screw.

## 1.1 Quality Assurance

A. Manufacturer Qualifications: With more than 90 years of engineering and manufacturing excellence, Organized Living delivers the strongest home storage and organization solutions for every area of the home.

B. Installer Qualifications: Factory trained and product experienced.

C. Provide Computer Generated 3-Dimensional drawings for each design variation.

D. Mock-Up: Provide a mock-up for evaluation of surface preparation techniques and application workmanship.

1. Finish areas designated by Architect.
2. Do not proceed with remaining work until workmanship, color, and product selection are approved by Architect.
3. Refinish mock-up area as required to produce acceptable work.

## 1.2 Delivery, Storage, and Handling

A. Store products in manufacturer's unopened packaging until ready for installation.

## 1.3 Project Conditions

A. Maintain environmental conditions (temperature, humidity, and ventilation) within limits recommended by manufacturer for optimum results. Do not install products under environmental conditions outside manufacturer's absolute limits.

## 1.4 Warranty

Manufacturer warrants for 10 years against defects in material and workmanship that impair the utility of the product. This warranty applies under conditions of normal use as a storage organization system. This warranty excludes product damage due to improper installation or product abuse or misuse, whether inflicted by an installing contractor, service company or others. Non residential applications are limited to a two year warranty.

## Part 2 Products

### 2.1 Manufacturers

A. Acceptable Manufacturer: Organized Living; 3100 E Kemper Rd, Cincinnati, OH 45241. Tel: (800) 669-3225. Tel: (513) 277-3700. Fax: (513) 277-3701. Email: customerservice@organizedliving.com. www.organizedliving.com

B. Substitutions: Not permitted due to Organized Living higher quality engineering specifications on wire and rod gauges and baked on epoxy powder coating.

C. Requests for substitutions will be considered in accordance with provisions of Section 01600. A. Product: FreedomRail Adjustable Shelving System.

### 2.2 Freedomrail Closet Systems

1. Rail mounted to wall with mounting hardware every 8 inches (203 mm).
- A. For heavy duty applications mount in studs or raise to ceiling to mount in sill plate.
2. Uprights spaced 36 inches apart, the shelf supports 50 pounds per lineal foot (77 kg/m), or 150 pounds (227 kg) on a 3 foot (914 mm) shelf. Uprights are mounted onto Rail and are not to be mounted to wall to allow future owner adjustment.
3. For extra heavy applications, uprights (610 mm) apart support 100 pounds per lineal foot (150 kg/m), or 200 pounds (300 kg) on a 2 foot (610 mm) shelf.

### C. Design:

1. Ventilated Wire Steel Hardware Baked-on Coated Color: White.
2. Ventilated Wire Steel Hardware Baked-on Coated Color: Nickel.

3. Melamine Thermal fused Color: White
4. Melamine Thermal Fused Color: Modern Cherry
5. Melamine Thermal Fused Color: Chocolate Pear
6. Melamine Thermal Fused Color: Driftwood Live
7. Melamine Thermal Fused Color: Midnight Live
8. Melamine Thermal Fused Color: Cypress Live
9. Melamine Thermal Fused Color: Granite

### D. Components:

1. Rails: Heavy-duty steel, .079 inch (2.0 mm) grade 1008 with a non-stick epoxy coating.
  - a. Available in 24 inches (610 mm), 30 inches, 36 inches, 40 inches (1016 mm), 64 inches (1626 mm) and 80 inches (2032 mm) lengths.
2. Mounting Hardware: Patented Strong-Loc hollow wall anchor system.
3. Uprights: Slotted vertical hanging channels. Heavy-duty steel, .071 inch (1.8 mm) grade 1008, coated with a non-stick epoxy coating. Lengths as indicated or required.
  - a. 30 inches (762 mm) uprights support long-hanging garments.
  - b. 48 inches (1219 mm) uprights support two rows of short hanging garments.
  - c. 78 inches (1981 mm) uprights support any type of hanging or shelving needs.
  - d. 90 inches (2286 mm) uprights support any type of hanging or shelving needs.
4. Shelving:
  - a. Ventilated Shelving with cross wires at ½ inch spacing and two .243 Inch (6.17mm) Double Back Rods in 9 inches (229 mm), 12 inches (305 mm), 16 inches (406 mm) and 20 inches (508 mm) depths as indicated or required.
  - b. Heavy Duty Ventilated Shelving in 12 inches (305 mm) or 16 inches (406 mm) depths as indicated or required.
  - c. 45 pound, furniture-grade melamine shelving in 8 inches (203 mm), 12 inches (305 mm), 14 inches (356 mm) depths as indicated or required.
  - d. Shoes shelves and desktops as scheduled or indicated.
  - e. Pre-cut lengths required.
5. Brackets: Heavy-duty steel, .065 inch (1.6 mm) grade 1008, coated with a non-stick epoxy coating.
  - a. Shelving brackets depending on the type of shelf indicated or required. Ventilated Shelf Brackets for 9 inches (229 mm), 12 inches (305 mm), 16 inches (406 mm) and 20 inches (508 mm) deep shelving and Wood Shelf brackets for 8 inches (203 mm), 12 inches (305 mm), 14 inches (356 mm) and 21 inches (533 mm) deep shelving.
  - b. Chrome or Nickel plated Rod Clips: Connection between the bracket and Clothes Rod, and do not interfere with hangers sliding along the rod.
  - c. Clothes Rods and Rod Stops: Chrome or nickel plated steel tubing. Clothes rods shall be mounted under shelf as scheduled or indicated.
6. Rod Clips: Heavy-duty steel, Chrome or Nickel plated
  - a. Rod Clips: Connection between the bracket and Clothes Rod, and do not interfere with hangers sliding along the rod.
  - b. Attaches to Ventilated Brackets 12 inches (305 mm) and 16 inches (406 mm) deep.
7. Clothes Rod: Heavy-duty Chrome or Nickel Plated
  - a. Clothes Rods: Chrome or nickel plated steel tubing. Clothes rods shall be mounted

under shelf as scheduled or indicated.

8. Rod Stops: Heavy-duty steel, Chrome or Nickel plated
  - a. Chrome or Nickel plated Rod Stops lock into all Hanging Rod to prevent material from falling off of the end.

### 9. Organizational Boxes (OBox):

- a. OBoxes are 24 inches (610 mm) W by 16 inches (406 mm) H by 14 inches (356 mm) D and are supported by uprights that are 24 inches (610 mm) apart.

1) All OBoxes are available in Shelf Unit, 2 Drawer, 3 Drawer, Shoe Cubby and Hanging File.

- b. Big OBoxes are 30 inches (762 mm) W by 20 inches (508 mm) H by 16 inches (406 mm) D, and are supported by uprights that are 30 inches (762 mm) apart.

1) All Big OBoxes are available in Shelf Unit, 2 Drawer, 3 Drawer and Cubby.

- c. Double Hang OBoxes are 24 inches (610 mm) W by 9-1/2 inches (241.3 mm) H by 14 inches (356 mm) D and are supported by uprights that are 24 inches (610 mm) apart

1) All Double Hang OBoxes are available in 1 Drawer, 2 Drawer and Cubby.

- d. Double Hang Big OBoxes are 30 inches (762 mm) W by 9-1/2 inches (241.3 mm) H by 16 inches (406 mm) D, and are supported by uprights that are 30 inches (762 mm)

1) All Double Hang Big OBoxes are available in 1 Drawer, 2 Drawer and Cubby.

### 10. Accessories: As indicated or scheduled.

- a. Jewelry inserts (black).
- b. Wine inserts (white).
- c. Paper sorter inserts.
- d. Drawer dividers.
- e. Chrome wire baskets.
- f. Chrome basket canvas inserts (Oatmeal and Chocolate canvas color).
- g. Back wall covers. OBox Backs
- h. Valet rod.
- i. Tie rack.
- j. Acrylic shelf divider.
- k. Epoxy coated wire shelf divider.
- l. Doors

## Part 3 Execution

### 3.1 Examination

A. Prepared spaces are sized and located in accordance with shop drawings.

B. Framing, reinforcement and anchoring devices are correct type and are located in accordance with shop drawings.

### 3.2 Preparation

A. Layout scheduled components prior to installation to verify wall to wall and floor to ceiling heights, widths, plumb and flatness of surfaces.

B. Prepare anchor locations and select anchor types using the methods recommended by the manufacturer for achieving the best result for the substrate under the project conditions.

### 3.3 Installation

A. Can be installed in any substrate in accordance with manufacturer's instructions.

B. Install components true to line, square with adjacent components with drawer glides and working hardware operating smoothly without binding, or gaps when closed.

### 3.4 Protection

A. Protect installed products until completion of project.

B. Touch-up, repair or replace damaged products before Substantial Completion.